

General Description

MAG SW100P SE is a new generation electro-mechanical complete system for automatic swing gate. It is composed primarily of an electronic panel unit that control actuator motor to open or close the gate in a swing motion.

MAG is the brand of confidence and highest standard in its class. SW100P SE has been carefully designed and thoroughly tested for Malaysia extreme weather condition. Its performance is continuously refined by 20 years of experience. Our stringent quality control guarantees the consistency and reliability of MAG swing gate system.

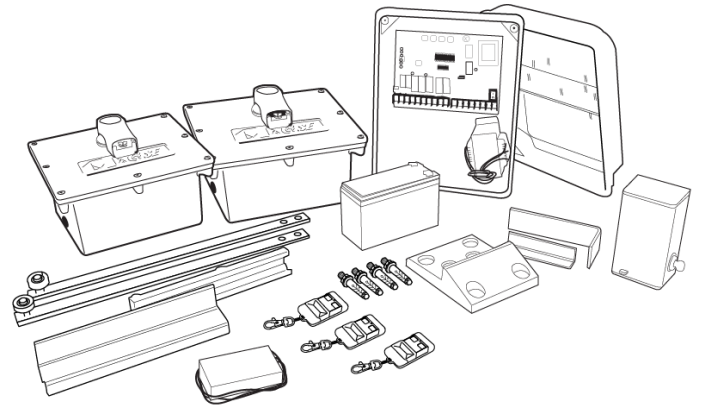

Application

Residential home with single gate leaf weight not exceeding 220 kg



Features

Good quality. MAG system major components are made of top grade tough, durable and rust resistance material.

Fast and silent. The actuator is capable for 90° opening within only 8 to 10 seconds and is exceptionally quiet in operation.

Last longer. Gear box is submerged in oil bath for more protection. This design significantly improves the actuator's mechanical life span.

Secure. DC powered lock ensures that there is no unauthorized opening of the gate. The gate can only be opened with the remote control transmitter or special key (during power failure).

Safe. Fully DC operation to avoid any potential electric hazard. Controller built in sensor to automatically cut motor power upon detection of possible collision.

Convenient. Remote control coded transmitter allow convenient operation for user in the vehicle within 30 to 50 meters from the gate.

Intelligent. Smart microprocessor is used in the control panel.

Gate leaf operation with cushioning - gate will slow down towards the end of opening or closing swing. This is to avoid the gate banging loudly into the stopper and pillar light wall at high speed.

Pillar light control

Support backup battery during power failure. Battery can last up to 30 opening and closing to provide you immediate convenient when there is no power. Battery needs to be changed every year to maintain same performance.

Advanced - Uni clutch mechanism. This unique slip-clutch mechanism automatically suspends gate's movement if it encounters any obstacle such as vehicle, human and animal in its traveling path.

This is very important to protect the safety of user and avoid the motor to overload itself (longer life time for motor). Uni-clutch is designed to exert uniform circular force onto the clutch plate for smoother rotation while maintaining strong rotation force. This is a true clutched system.

Patented technology

MAG SE actuator advanced drive mechanism and clutch system is patented in UK (2264534) and Malaysia (MY103093A). MAG is the first and original system in the world that has this patented technology.

Ordering information

Ordering code:

SW100P1	No backup battery
SW100P2	With backup battery

System package consist of the following:

2 pcs	MAG SE SW100 swing gate actuator
1 set	Lock solenoid lock & stopper
2 pcs	Key for manual release
2 set	Actuator arm & bracket
1 set	Control panel w/ transformer
1 pcs	ABS weather resistant plastic casing
1 set	Remote control w/ 3 transmitter

Technical specification

Actuator

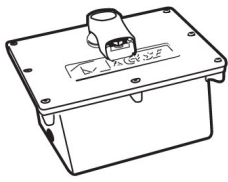

A rotary drive unit complete with DC motor, speed reducer and electro-mechanical clutch system housed in a waterproof rust resistance cast alloy casing. Actuator drives the gate leaf to move.

UK and Malaysia patented technology.

Motor voltage rating	12-24 V DC
Power consumption	23 watt per actuator
Trust force	0 to 60 kg
Max Opening angle	360 °
Max leaf weight allowable	220 kg
Motor rated load speed	4700 RPM
Actuator output speed	2.2 RPM
Traveling speed	8 - 10 sec for 90°
Dimension	25.5 x 24.4 x 13 cm

Control panel

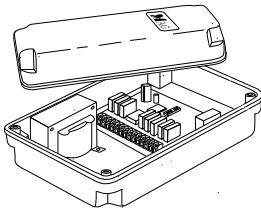

Consists of an advanced microprocessor based PCB, and transformer housed in weather resistant casing. Controls operation of the whole swing auto gate system.

Functions:

<ul style="list-style-type: none"> Adjustable Dual speed gate control
<ul style="list-style-type: none"> Gate leaf opening and closing with cushioning
<ul style="list-style-type: none"> Automatic pillar light control
<ul style="list-style-type: none"> Single or two gate leaf open; selectable from remote control transmitter or in house push button
<ul style="list-style-type: none"> Adjustable opening/closing angle. Gate can be stopped immediately and resume motion at any angle.
<ul style="list-style-type: none"> Adjustable safety collision force to cut of motor power.
<ul style="list-style-type: none"> Built in secondary transformer to protect control panel from possible electric surge to provide consistent motor performance.
<ul style="list-style-type: none"> Built in charger to support backup battery

Power supply input: AC 230 V. Available DC 12V and 24V output for actuator.

Housing is made from weather proof ABS plastic. Housing dimension: 25.5 x 31 x 12 cm

Remote control & transmitter

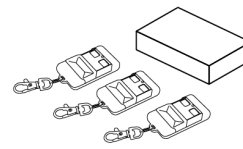

Consist of a receiver and transmitters. Allows gate operation to be controlled remotely within the specified range.

Range	Effective 30m.
Transmitter dimension	6 x 3.5 x 1.3 cm
Receiver dimension	9.5 x 5.4 x 2.6 cm

Modulated RF transmission. Transmission coding (6561 combinations) is set by 8x3 DIP switches in the receiver and transmitter - easily accessible and changed by owner. Coding on both sides must be the same for it to work.

Receiver is installed inside the ABS casing together with control panel. Transmitter uses a single 12V small size alkaline battery - normal usage should last 6 months. First button for full open and second button for half open.

Solenoid lock

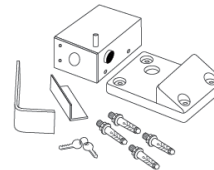

Consist of a solenoid lock, stopper, keys, L-bar, angle bar and 4 set anchors. It automatically locks the gate when it is closed.

Rated voltage	12 V DC
Locking stopper	Solid mild steel coated with hard PVC
Manual override	Key operated cam-lock to enable manual operation in the event of power failure
Solenoid lock dimension	6.6 x 8 x 14 cm

Actuator arm & bracket

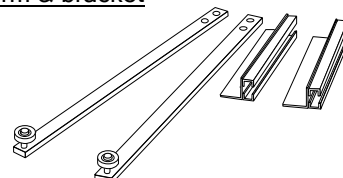

Consist of two arms and two brackets. These are the supporting component that connects the gate to the actuator output shaft. Both are made from good material: Nickel-Chrome plated mild steel.

Arm's dimension: 45.3 x 2.5 x 0.6 cm
Bracket dimension: 21.5 x 4 x 5.8 cm

Wiring and installation diagram

This wiring diagram only shows the correct point-to-point electrical connection. It does not represent the underground wiring path in actual installation. Underground wirings are protected by PVC conduits.

Push button on an elegant plastic plate is mounted inside the house.

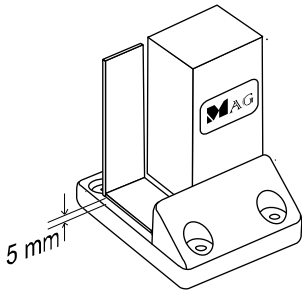
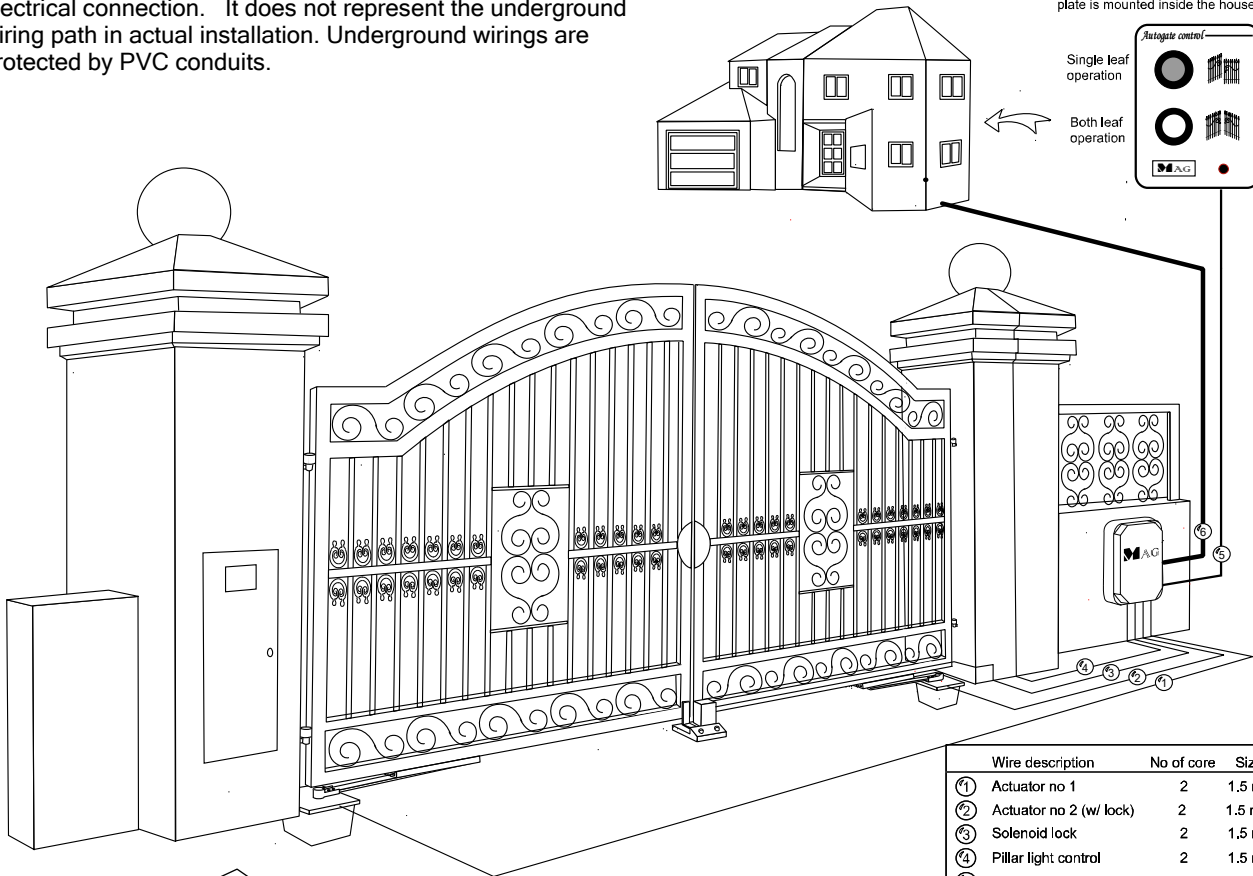

Solenoid lock and L-bar must maintain 5 mm gap above the stopper surface to avoid damaging the rubber coating.

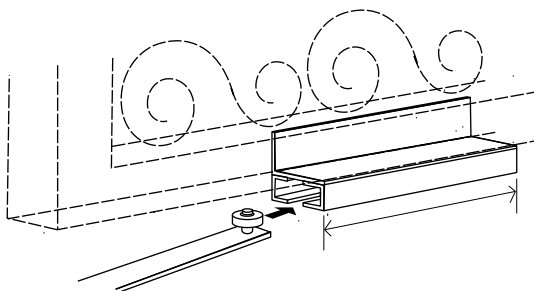
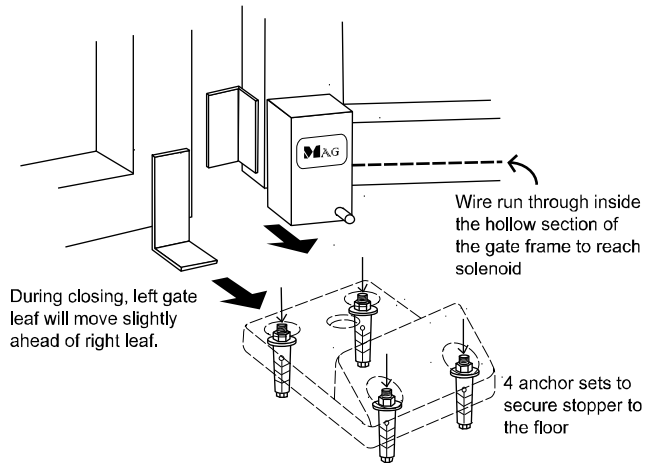

The purpose of the bracket is to contain the arm's bearing roller movement as the gate open or close. The bracket mounted should be able to completely include the maximum travelling path of the roller bearing as the gate swing from fully close to fully open position.

The final location of the bracket varies depending on the installation site - and it has to be measured again for every new installation. Failure to mount the bracket accurately will cause the bearing roller to fall out when gate is fully open or fully close.

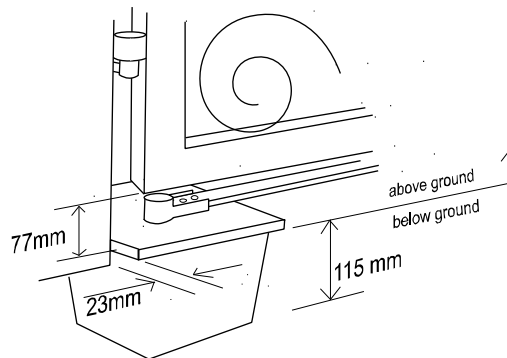

****Suggested dimension and diagrams are for illustration only and do NOT reflect actual installation. Actual installation varies depending on site.**

Packaging information

Single complete system of SW100P SE (with any possible optional items) can be packed into the following two boxes for shipment.

Approximate total weight = 5 kg

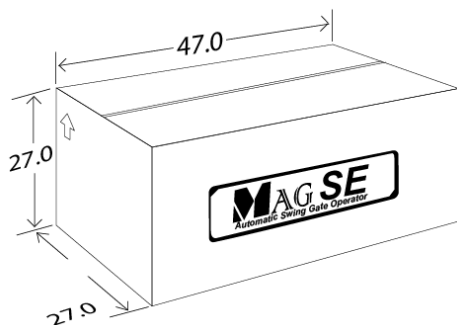

Two actuators, arms and brackets

SW100P1 No backup battery = 7 kg
SW100P2 With backup battery = 5 kg

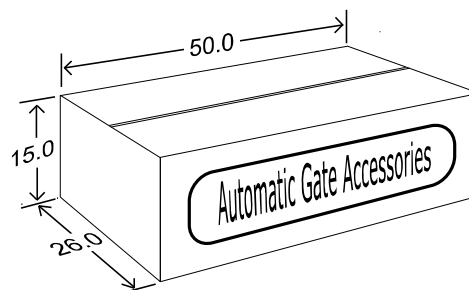

Control panel, solenoid lock, L-bar, angle bar, keys, remote control receiver & transmitter and any other optional accessories.

Optional accessories



Extra remote control transmitter for family member

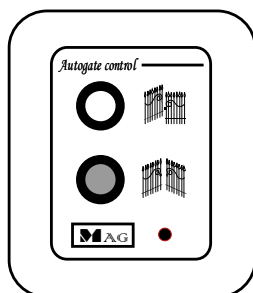

Push button panel plate for auto gate control. Its simple and elegant design made it looks good on the wall of any color.

Distributor/installer:

© COPYRIGHT 20 Oct 2011. All diagrams are for illustration only and does not necessary reflect the actual exact assembly/installation. This documentation served as a reference only. It is subject to change without further notice. All the diagrams and information in this documentation may not be duplicated or modified in any form without the written approval from MAG®.